

access

LIGHTING

IMPORTANT SAFETY INSTRUCTIONS

MESURES DE SECURITE A RESPECTER

Before assembling your ACCESS LIGHTING fixture, please make sure that you carefully read through this instruction sheet. Save this instruction sheet and refer to it when additions to or changes in the fixture configuration are made.

Lisez attentivement ce manuel d'instructions. Enregistrer cette feuille d'instructions et de s'y référer lorsque les ajouts ou changements dans la configuration de montage sont faites.

CONSULT A QUALIFIED ELECTRICIAN TO ENSURE CORRECT BRANCH CIRCUIT CONDUCTOR.

CONSULTER UN ELECTRICIEN QUALIFIE POUR VOUS ASSURER QUE LES CONDUCTEURS DE LA DERIVATION SONT ADEQUATS

THIS PRODUCT MUST BE INSTALLED IN ACCORDANCE WITH THE APPLICABLE INSTALLATION CODE BY A PERSON FAMILIAR WITH THE CONSTRUCTION AND OPERATION OF THE PRODUCT AND THE HAZARDS INVOLVED.

CE PRODUIT DOIT ETRE INSTALLE SELON LE CODE D'INSTALLATION PERTINENT, PAR UNE PERSONNE QUI CONNAIT BIEN LE PRODUIT ET SON FONCTIONNEMENT AINSI QUE LES RISQUES INHERENTS

NOTE: The important safeguards and instructions that appear in this manual are not meant to cover all possible conditions and situations that may occur. It must be understood that common sense, caution and care, are factors that can't be built into any product. These factors must be supplied by the person(s) caring for and operating the fixture.

Read all instructions

Do not install this fixture in hazardous locations.

N'installez pas cet appareil dans des emplacements dangereux.

Do not install any fixture assembly closer than 6 inches from any curtain or similar combustible material.

Laissez une distance d'au moins 6 pouces entre ce luminaire et la toute surface combustible.

"WARNING Risk of Fire and Electric Shock."

"CAUTION: Risque d' Incendie et de Choc Electriques."



COLLECTION

VAIL

APPLICATION

Wall Fixture

MODEL NO.

31001LEDD

WHAT WE PROVIDE

- Mounting Hardware
- Fixture Assembly
- Crossbar
- Glass Shade
- LED Module

WHAT YOU NEED

- Screwdriver
- Wire Cutters
- Wiring Supplies as Specified by Electrical Code

GENERAL INFORMATION

All electrical connections must be in accordance with all ordinances, Local and the U.S. National Electrical Codes (NEC). These fixtures are intended for mounting to a standard 4" metal octagon outlet box.

The box must be directly supported by the building structure and U.L. Recognized.

STEP BY STEP INSTRUCTIONS

Before starting your installation disconnect the Power by turning off the Circuit Breaker or by removing the fuse at the fuse box. Just turning the light off at the light switch is not sufficient to prevent electrical shock.

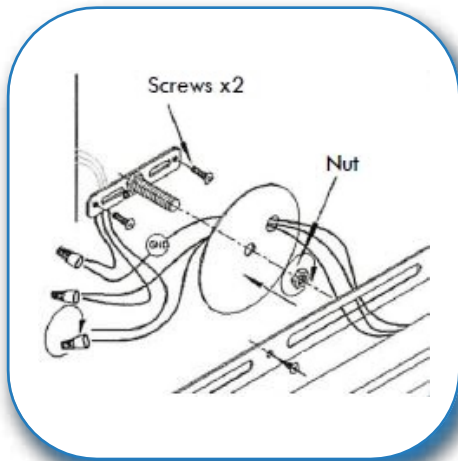

1

PREPARE FIXTURE

If there is an existing fixture remove it.
Expose the supply wires from the J-Box.
Secure the crossbar to the J-box with the supplied screws.
Ensure that the nipple already inserted into the crossbar faces outward.

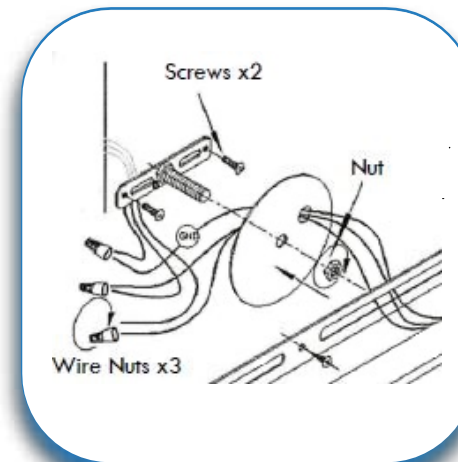

2

CONNECT THE WIRES

Gently pull the supply wires through the outer hole in the metal plate. Connect the black supply wire to the black fixture wire. Secure with the supplied wire nuts. Connect the white supply wire to the white fixture wire. Secure with the supplied wire nuts. Attach the green J-Box wire around green hexagonal head screw or connect it to the green supply grounding wire of the fixture. Secure all wires with U.L. Certified electrical tape (not supplied). Tuck all wires carefully into the J-Box.

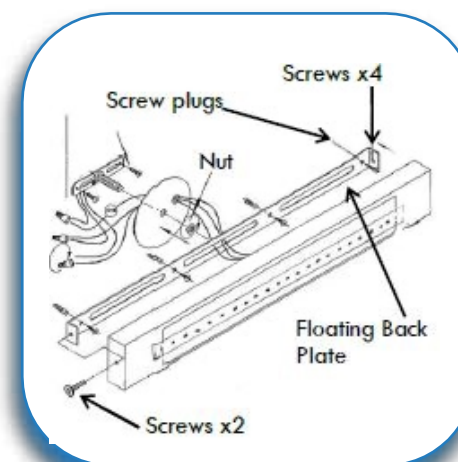

3

MOUNT THE CANOPY

Position the floating back plate in the desired location, mark screw holes with a pencil and then drill holes. Place the supplied screw plugs into the holes. Insert the nipple through the center hole in the metal plate. Now fit the nipple through the closest hole available in the floating back plate. Secure with the supplied nut. Secure the floating back plate to the wall with the supplied screws. Fit the fixture plate over the floating back plate ensuring that the two holes on either end of both plates are aligned. Secure with the supplied screws.

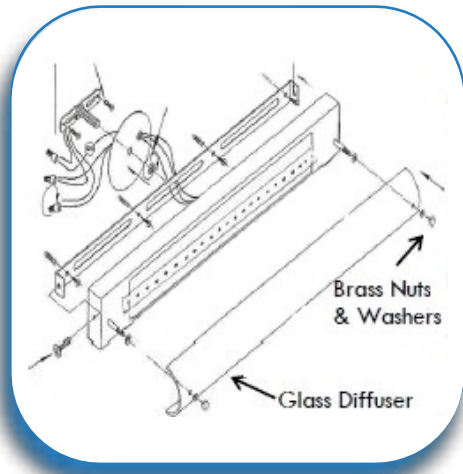

4

SECURE THE GLASS SHADE

Secure the glass diffuser by fitting the screws on the face of the fixture plate through the holes allocated in the glass diffuser. Secure with the supplied washers and brass nuts.

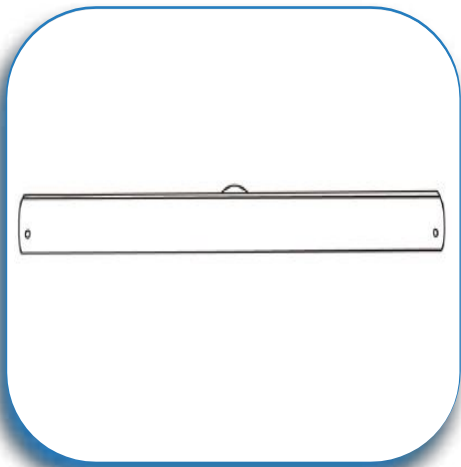

5

RESTORE THE ELECTRICITY AND CHECK THE OPERATION OF YOUR NEW ACCESS LIGHTING FIXTURE

